

ADEPT

CONCEPT by *ekol*



Introduction

The range of options for the Adept concept will never stop developing...

...The evolution of the firebox for the perfect burn maybe complete with the Ekol Adept, but the design potential of its outer surrounding options and the ways in which Adept could interact with you and your environment are infinite.

The Adept Concept is simply based on Ekol's passion to combine the perfect fire experience with practical and beautiful design that can morph to suit your individual style, lifestyle and home.

Ekol-Adept is a highly advanced stove concept. Precision engineered dual layer steel construction, this is a very heavy duty woodburner and will efficiently heat your room to perfection via warm air convection as well as infra-red, thermal radiant heat.

Designed to burn in style, there are literally limitless options with this stove, so that it becomes your own truly bespoke piece of engineered design.

Ekol Adept can be fully room-sealed and fed air from outside meaning it need not take air from the room.

Huge viewing window and super-pre-heated airwash air keeps the screen unbelievably clean and clear for mesmerising views of the advanced combustion chamber.

We believe there is great beauty in something so perfectly engineered that it appears so simple.

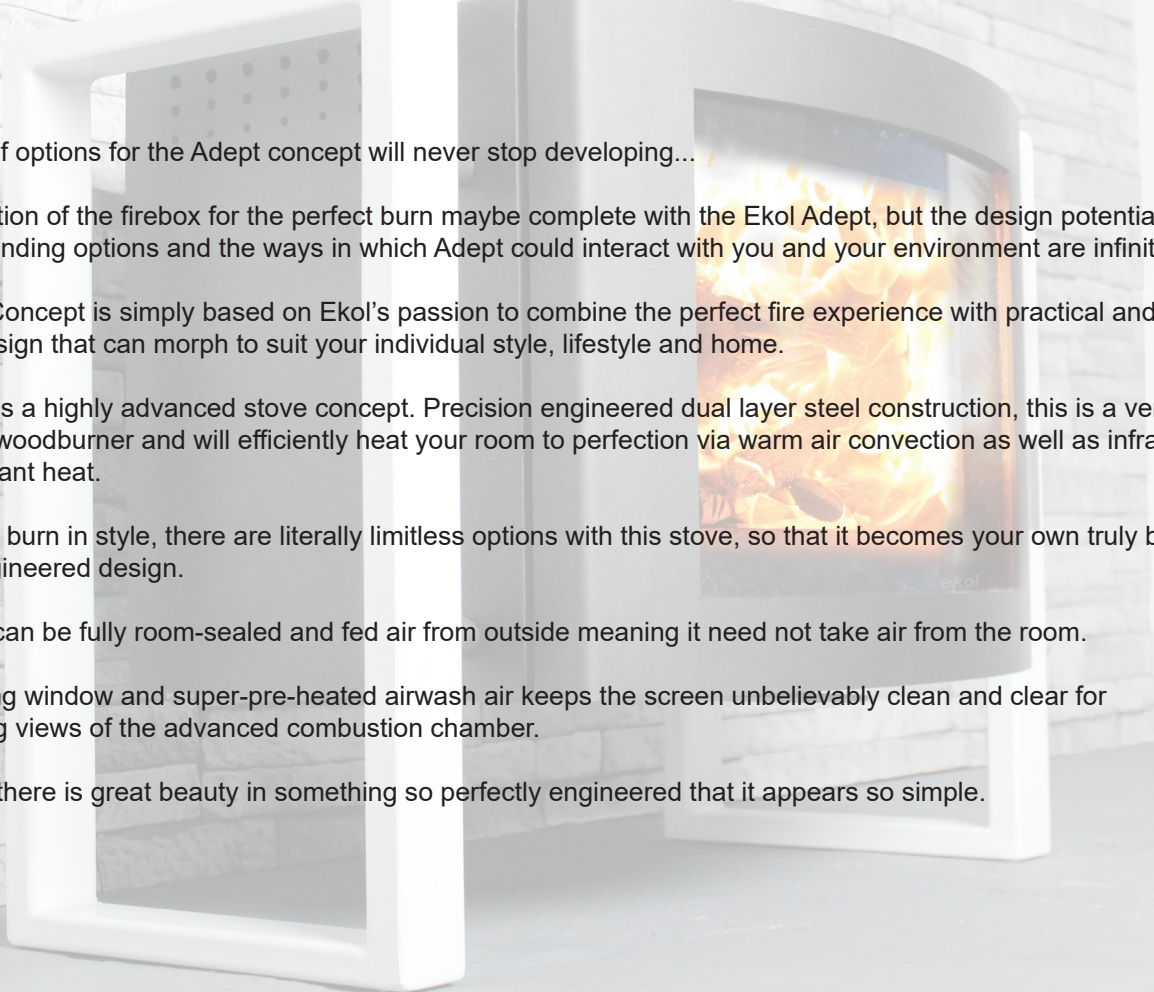

Achievable Heat Output Range	2.0 to 7.5kW
Nominal Heat Output	5.0kW
Efficiency	80.3%
DEFRA Exempt for UK Smoke Control Areas	✓
EcoDesign 2022 Ready	✓
clearSkies level 4	✓
Tested to BS, EN (CE), UK Smoke Control (DEFRA), EcoDesign 2022 tested and compliant	✓
Suggested Clearances to Non-combustible materials	30mm all round (to suitably thick solid materials)
Minimum Clearances to Combustible materials:	<ul style="list-style-type: none"> • Rear of stove = 200mm (as a free standing stove), when used with optional heat-shield. • Sides of stove = 250mm (when used as a FREE-STANDING stove). • Sides of stove = 100mm (when used as an INSET stove). • Above = 400mm
Suitable for positioning on hearth of just 12mm thick	✓
10 Year body warranty	✓
Dual fuel capable, bioethanol and wood (fuels must never be used together), when purchased with optional bioethanol burner system (1.5kW output on bioethanol)	✓ (5 hour refuel period when using bioethanol)
Air vent in room NOT usually required.	✓
Optional external air kit available for more air-tight buildings (uses 3 inch or 4 inch ducting)	✓
Removable cool-touch handle/ multitool included	✓



Adept Classic

With Simple elegant legs. Self adjusting for uneven floors. Available in 60mm or 100mm leg heights (or bespoke heights on request). Certified for use as both a freestanding and inset type stove, Adept blurs the lines between these two types of stove which people normally have to choose between. Due to the dual layer convection body of the Adept and its low clearances to walls required, fitting it into tight spaces is no problem (30mm air gaps recommended).

As with all Adept models, choose from three door type options, Regular, Printed Glass Front (double-glazed) or Curved Door/Glass.

Key Features

Nominal Heat Output	5 kW
High Efficiency	✓ 80.3%
Dual Fuel ready	✓
Ultra Clean Burn	✓
Optimum Heat Output Range	2 to 7.5kW
Advanced Airwash	✓
Maximum Log Length	18"(450mm)
10 Year Body warranty	✓
DEFRA Exempt for Smokeless Zones	✓
Large View Ceramic Glass	✓
Optional Mirror glass	✓
Flue Outlet Top or Rear	5(125mm)
Suitable for use on a 12mm Hearth	✓



Dimensions

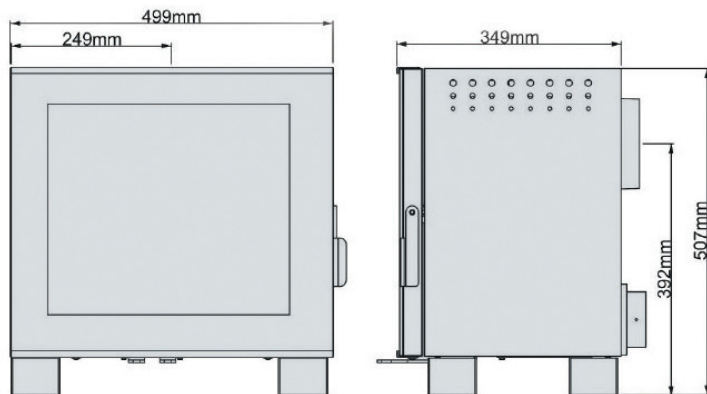

Adept Pedestal

Here the Adept is given a curved cylindrical front with matching extra-strong curved glass, and raised on its integrated pedestal base.

The base has its own magnetic closing door concealing a large storage base underneath.

Key Features

Nominal Heat Output	5 kW
High Efficiency	✓ 80.3%
Dual Fuel ready	✓
Ultra Clean Burn	✓
Optimum Heat Output Range	2 to 7.5kW
Advanced Airwash	✓
Maximum Log Length	18"(450mm)
10 Year Body warranty	✓
DEFRA Exempt for Smokeless Zones	✓
Large View Ceramic Glass	✓
Optional Mirror glass	✓
Flue Outlet Top or Rear	5(125mm)
Suitable for use on a 12mm Hearth	✓

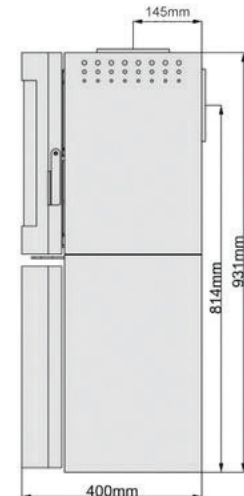
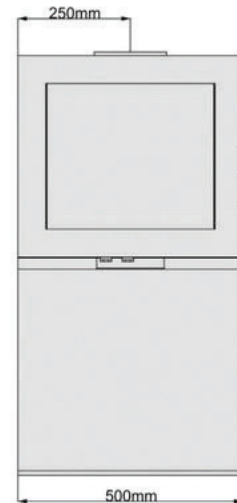

Adept Inset

The Adept has a much shorter install time compared to most inset / 'cassette' type stoves -

This is due to the integrated dual layers of thick steel which make up every Adept stove.

Simply fire-board out the aperture in the wall, slide the Adept into the recess keeping 30mm gap all around, then connect the flue from inside the stove.

As with all Adept models, choose from three door type options, Regular, Printed Glass Front (double-glazed) or Curved Door/Glass.

Key Features

Nominal Heat Output	5 kW
High Efficiency	✓ 80.3%
Dual Fuel ready	✓
Ultra Clean Burn	✓
Optimum Heat Output Range	2 to 7.5kW
Advanced Airwash	✓
Maximum Log Length	18"(450mm)
10 Year Body warranty	✓
DEFRA Exempt for Smokeless Zones	✓
Large View Ceramic Glass	✓
Optional Mirror glass	✓
Flue Outlet Top or Rear	5(125mm)
Suitable for use on a 12mm Hearth	✓



Dimensions

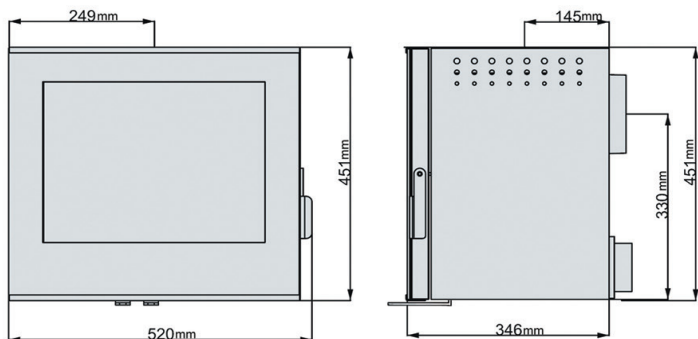



Can be used with separate trim (optional extra)

Or simply set into a rendered aperture





Key Features

Nominal Heat Output	5 kW
High Efficiency	✓ 80.3%
Dual Fuel ready	✓
Ultra Clean Burn	✓
Optimum Heat Output Range	2 to 7.5kW
Advanced Airwash	✓
Maximum Log Length	18"(450mm)
10 Year Body warranty	✓
DEFRA Exempt for Smokeless Zones	✓
Large View Ceramic Glass	✓
Optional Mirror glass	✓
Flue Outlet Top or Rear	5(125mm)
Suitable for use on a 12mm Hearth	✓

Adept Steel Base Frames

The Adept Steel Base has a contemporary steel base. The stove is available in a range of colours and the steel base is also available in gloss white.

As with all Adept models, choose from three door type options, Regular, Printed Glass Front (double-glazed) or Curved Door/Glass.

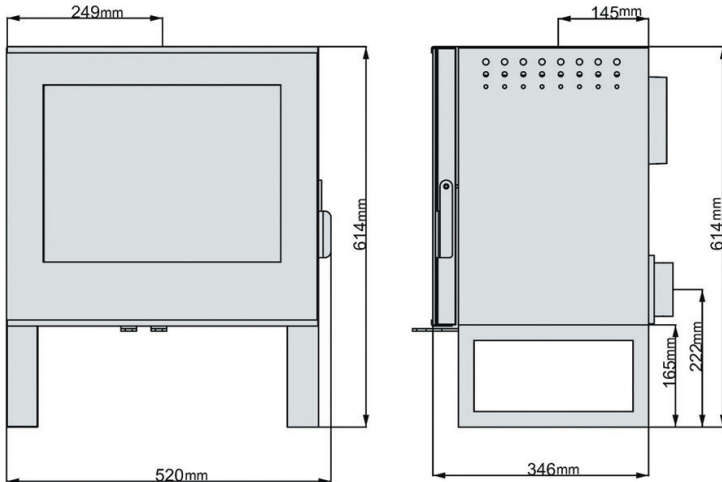



Key Features

Nominal Heat Output	5 kW
High Efficiency	✓ 80.3%
Dual Fuel ready	✓
Ultra Clean Burn	✓
Optimum Heat Output Range	2 to 7.5kW
Advanced Airwash	✓
Maximum Log Length	18"(450mm)
10 Year Body warranty	✓
DEFRA Exempt for Smokeless Zones	✓
Large View Ceramic Glass	✓
Optional Mirror glass	✓
Flue Outlet Top or Rear	5(125mm)
Suitable for use on a 12mm Hearth	✓

Adept Steel Side Frames

As well as giving the Adept a unique look poised between the supports, the side frames also help to increase the stove's overall width giving it more of a presence across an expansive wall or hearth, or when positioned in a larger fireplace recess.

As with all Adept models, choose from three door type options, Regular, Printed Glass Front (double-glazed) or Curved Door / Glass. Optional colour finishes for steel frames

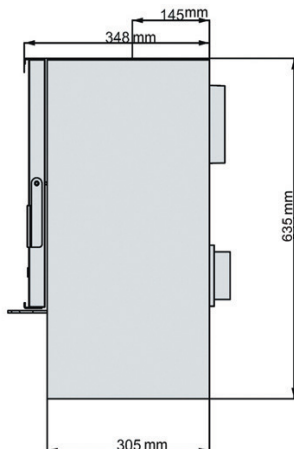
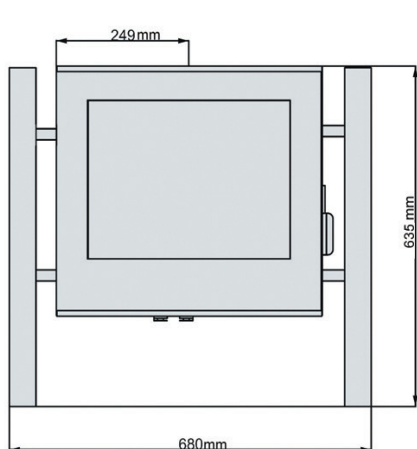



Key Features

Nominal Heat Output	5 kW
High Efficiency	✓ 80.3%
Dual Fuel ready	✓
Ultra Clean Burn	✓
Optimum Heat Output Range	2 to 7.5kW
Advanced Airwash	✓
Maximum Log Length	18"(450mm)
10 Year Body warranty	✓
DEFRA Exempt for Smokeless Zones	✓
Large View Ceramic Glass	✓
Optional Mirror glass	✓
Flue Outlet Top or Rear	5(125mm)
Suitable for use on a 12mm Hearth	✓

Adept Concrete Side Supports

Combining the Adept stove which floats between two vertical panels of Ekol's own CPRTPC (Ceramic Polymer Reinforced Thermal Polished Concrete).

As with all Adept models, choose from three door type options, Regular, Printed Glass Front (double-glazed) or Curved Door/Glass.

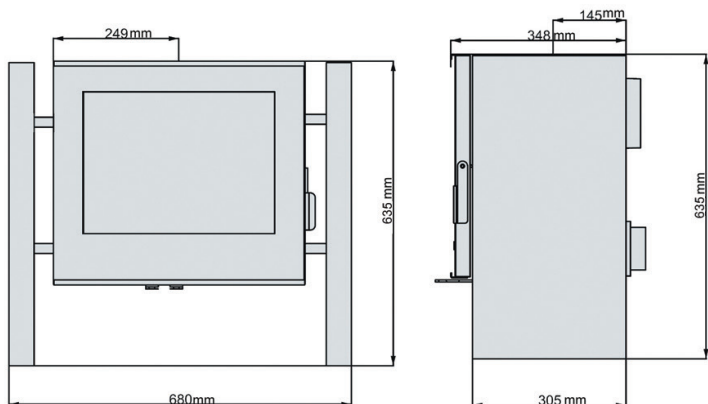



Optional Bioethonal fuel tray....

An (optional) insert system easily lifts in and out of the main firebox allowing the Adept to burn bioethanol liquid fuel which is easy to light, totally clean burning and almost 100% efficient in burning.

Giving out around 1.5 kW of constant heat, a single re-fill lasts up to 5 hours and can be used anytime of year for a warming real-flame fire without having to use logs.

The precision engineered stainless steel burner houses a ceramic wick material which gently and safely releases the fuel at the optimum rate.

When used with bioethanol only, the Adept does not need a chimney system to be installed as the fuel burns so clean and efficiently, extra room ventilation is normally not required.

The burner system can simply be lifted out and used outside on the patio table when alfresco dining.

Easy to switch off in an instant. Fuel available at most DIY stores as well as online.

Options.....

External Air supply box.

Available in 3" (for tight access situations) and standard 4"

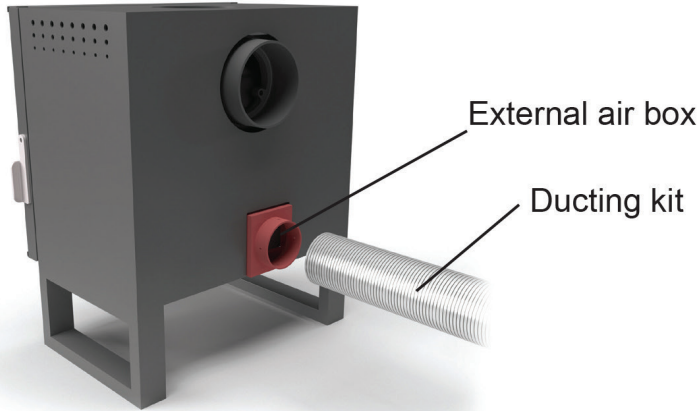

Door and Glass Options



Standard Door and Glass



Curved Door and glass



Glass Fronted Door
(Double glazed)

Colours:

(colours may vary from printed swatches below, for guidance only)

Metallic black (standard)

Charcoal

Light Grey

Silver

Metallic Blue

Patriot Blue

Special request colours can also be specified (call or email for details)

Side and base frame legs can also be finished in Gloss White.

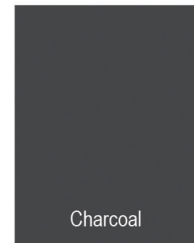
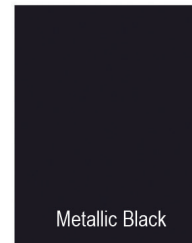

Tech' & Spec' ...

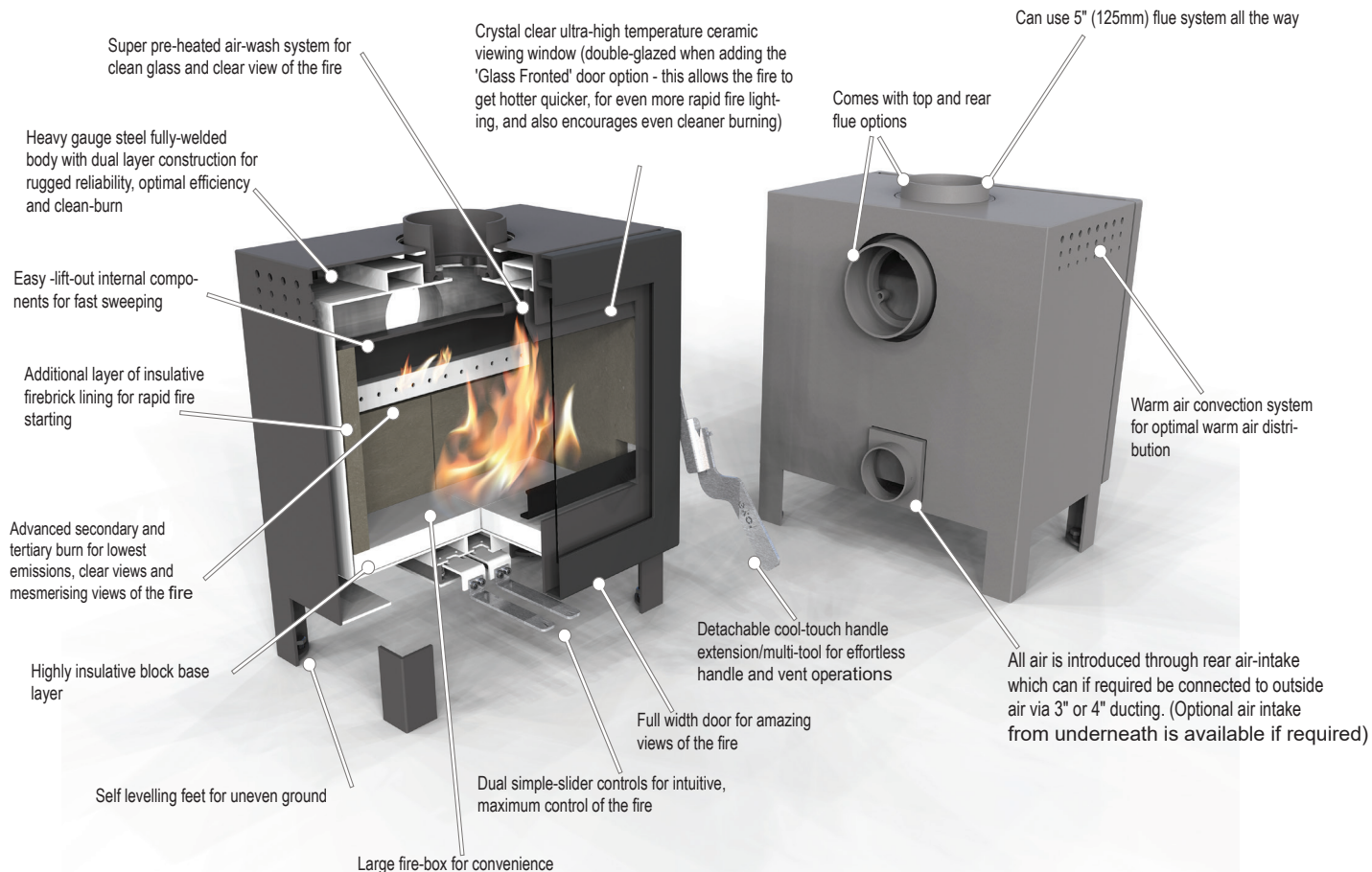

Configure your Adept Stove

	Step 1 Select your model	Step 2 Select door colour	Step 3 Select body colour	Step 4 Select Door Type			External Air box Required?		External Air Ducting Kit Required?		Select colour of Legs/Supports?	Bioethanol Kit Required?	Rear Heat Shield Required?	Optional Trim for Inset Required?		
				Standard	Glass Fronted (D/g/lazed)	Curved Door & Glass)	None	Rear connection	Underneath connection	None					3" (80mm)	4" (80mm)
															Leg Height	
INSET													N/A			
CLASSIC														N/A		
CONCRETE SIDES														N/A		
STEEL BASE FRAME														N/A		
STEEL SIDE FRAME														N/A		
PEDESTAL BASE					Curved door included as standard									N/A		



Colour options (Please write your chosen colours in columns provided)

Additional Notes

.....

.....

.....

.....

.....

.....

.....

.....

.....

.....



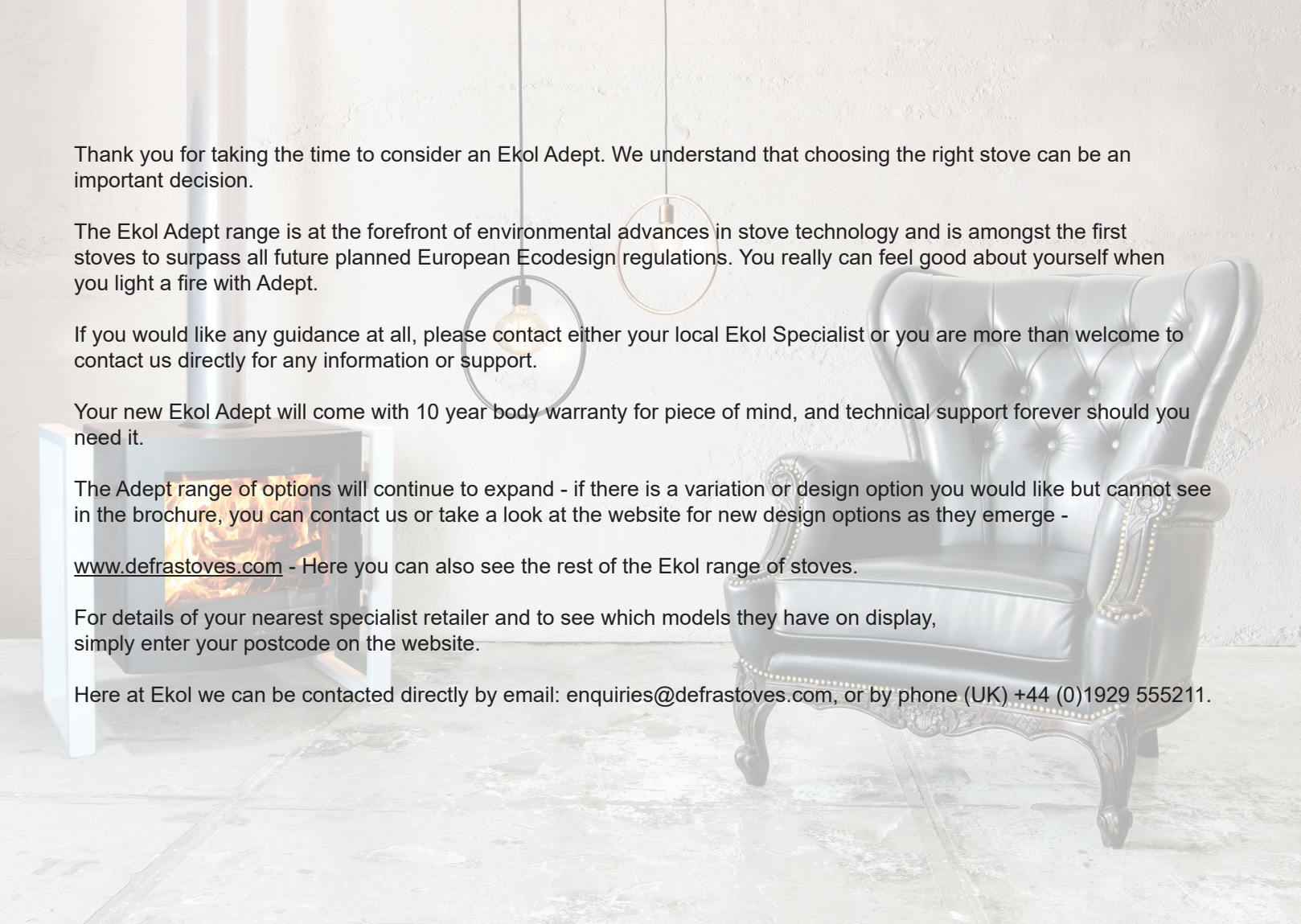

Thank you for taking the time to consider an Ekol Adept. We understand that choosing the right stove can be an important decision.

The Ekol Adept range is at the forefront of environmental advances in stove technology and is amongst the first stoves to surpass all future planned European Ecodesign regulations. You really can feel good about yourself when you light a fire with Adept.

If you would like any guidance at all, please contact either your local Ekol Specialist or you are more than welcome to contact us directly for any information or support.

Your new Ekol Adept will come with 10 year body warranty for piece of mind, and technical support forever should you need it.

The Adept range of options will continue to expand - if there is a variation or design option you would like but cannot see in the brochure, you can contact us or take a look at the website for new design options as they emerge -

www.defrastoves.com - Here you can also see the rest of the Ekol range of stoves.

For details of your nearest specialist retailer and to see which models they have on display, simply enter your postcode on the website.

Here at Ekol we can be contacted directly by email: enquiries@defrastoves.com, or by phone (UK) +44 (0)1929 555211.



www.defrastoves.com +44 (0)1929 555211